

# High-Power NPN Silicon Transistors

... designed for use in industrial–military power amplifier and switching circuit applications.

- High Collector–Emitter Sustaining Voltage –
 
$$V_{CE(sus)} = 100 \text{ Vdc (Min) - 2N6338}$$

$$= 150 \text{ Vdc (Min) - 2N6341}$$
- High DC Current Gain –
 
$$h_{FE} = 30 - 120 @ I_C = 10 \text{ Adc}$$

$$= 12 \text{ (Min) @ } I_C = 25 \text{ Adc}$$
- Low Collector–Emitter Saturation Voltage –
 
$$V_{CE(sat)} = 1.0 \text{ Vdc (Max) @ } I_C = 10 \text{ Adc}$$
- Fast Switching Times @  $I_C = 10 \text{ Adc}$ 

$$t_r = 0.3 \text{ ms (Max)}$$

$$t_s = 1.0 \text{ ms (Max)}$$

$$t_f = 0.25 \text{ ms (Max)}$$
- These devices are available in Pb–free package(s). Specifications herein apply to both standard and Pb–free devices. Please see our website at [www.onsemi.com](http://www.onsemi.com) for specific Pb–free orderable part numbers, or contact your local ON Semiconductor sales office or representative.

**\*MAXIMUM RATINGS**

Rating	Symbol	2N6338	2N6341	Unit
Collector–Base Voltage	$V_{CB}$	120	180	Vdc
Collector–Emitter Voltage	$V_{CEO}$	100	150	Vdc
Emitter–Base Voltage	$V_{EB}$	6.0		Vdc
Collector Current	$I_C$			Adc
Continuous		25		
Peak		50		
Base Current	$I_B$	10		Adc
Total Device Dissipation	$P_D$			Watts
@ $T_C = 25^\circ\text{C}$		200		
Derate above $25^\circ\text{C}$		1.14		W/ $^\circ\text{C}$
Operating and Storage Junction Temperature Range	$T_J, T_{stg}$	–65 to +200		$^\circ\text{C}$

**THERMAL CHARACTERISTICS**

Characteristic	Symbol	Max	Unit
Thermal Resistance, Junction to Case	$\theta_{JC}$	0.875	$^\circ\text{C/W}$

\*Indicates JEDEC Registered Data.

**2N6338**  
**2N6341\***

\*ON Semiconductor Preferred Device

**25 AMPERE**  
**POWER TRANSISTORS**  
**NPN SILICON**  
**100, 120, 140, 150 VOLTS**  
**200 WATTS**

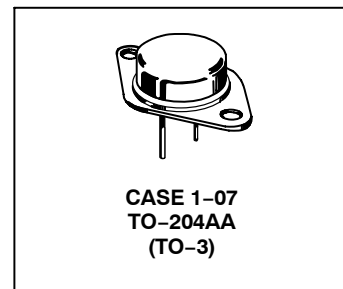

Preferred devices are ON Semiconductor recommended choices for future use and best overall value.

## 2N6338 2N6341

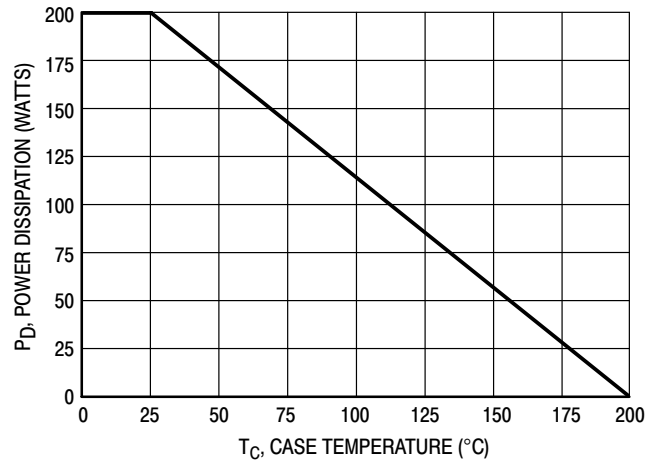

**Figure 1. Power Derating**

**\*ELECTRICAL CHARACTERISTICS** (T<sub>C</sub> = 25°C unless otherwise noted)

Characteristic	Symbol	Min	Max	Unit
<b>OFF CHARACTERISTICS</b>				
Collector–Emitter Sustaining Voltage (1) (I <sub>C</sub> = 50 mAdc, I <sub>B</sub> = 0)	2N6338 2N6341 V <sub>CEO(sus)</sub>	100 150	– –	Vdc
Collector Cutoff Current (V <sub>CE</sub> = 50 Vdc, I <sub>B</sub> = 0) (V <sub>CE</sub> = 75 Vdc, I <sub>B</sub> = 0)	2N6338 2N6341 I <sub>CEO</sub>	– –	50 50	μAdc
Collector Cutoff Current (V <sub>CE</sub> = Rated V <sub>CEO</sub> , V <sub>EB(off)</sub> = 1.5 Vdc) (V <sub>CE</sub> = Rated V <sub>CEO</sub> , V <sub>EB(off)</sub> = 1.5 Vdc, T <sub>C</sub> = 150°C)	I <sub>CEX</sub>	– –	10 1.0	μAdc mAdc
Collector Cutoff Current (V <sub>CB</sub> = Rated V <sub>CB</sub> , I <sub>E</sub> = 0)	I <sub>CBO</sub>	–	10	μAdc
Emitter Cutoff Current (V <sub>BE</sub> = 6.0 Vdc, I <sub>C</sub> = 0)	I <sub>EBO</sub>	–	100	μAdc

**ON CHARACTERISTICS (1)**

DC Current Gain (I <sub>C</sub> = 0.5 Adc, V <sub>CE</sub> = 2.0 Vdc) (I <sub>C</sub> = 10 Adc, V <sub>CE</sub> = 2.0 Vdc) (I <sub>C</sub> = 25 Adc, V <sub>CE</sub> = 2.0 Vdc)	h <sub>FE</sub>	50 30 12	– 120 –	–
Collector Emitter Saturation Voltage (I <sub>C</sub> = 10 Adc, I <sub>B</sub> = 1.0 Adc) (I <sub>C</sub> = 25 Adc, I <sub>B</sub> = 2.5 Adc)	V <sub>CE(sat)</sub>	– –	1.0 1.8	Vdc
Base–Emitter Saturation Voltage (I <sub>C</sub> = 10 Adc, I <sub>B</sub> = 1.0 Adc) (I <sub>C</sub> = 25 Adc, I <sub>B</sub> = 2.5 Adc)	V <sub>BE(sat)</sub>	– –	1.8 2.5	Vdc
Base–Emitter On Voltage (I <sub>C</sub> = 10 Adc, V <sub>CE</sub> = 2.0 Vdc)	V <sub>BE(on)</sub>	–	1.8	Vdc

**DYNAMIC CHARACTERISTICS**

Current–Gain – Bandwidth Product (2) (I <sub>C</sub> = 1.0 Adc, V <sub>CE</sub> = 10 Vdc, f <sub>test</sub> = 10 MHz)	f <sub>T</sub>	40	–	MHz
Output Capacitance (V <sub>CB</sub> = 10 Vdc, I <sub>E</sub> = 0, f = 0.1 MHz)	C <sub>ob</sub>	–	300	pF

**SWITCHING CHARACTERISTICS**

Rise Time (V <sub>CC</sub> ≈ 80 Vdc, I <sub>C</sub> = 10Adc, I <sub>B1</sub> = 1.0 Adc, V <sub>BE(off)</sub> = 6.0 Vdc)	t <sub>r</sub>	–	0.3	μs
Storage Time (V <sub>CC</sub> ≈ 80 Vdc, I <sub>C</sub> = 10 Adc, I <sub>B1</sub> = I <sub>B2</sub> = 1.0 Adc)	t <sub>s</sub>	–	1.0	μs
Fall Time (V <sub>CC</sub> ≈ 80 Vdc, I <sub>C</sub> = 10 Adc, I <sub>B1</sub> = I <sub>B2</sub> = 1.0 Adc)	t <sub>f</sub>	–	0.25	μs

\*Indicates JEDEC Registered Data.

(1) Pulse Test: Pulse Width ≤ 300 μs, Duty Cycle ≤ 2.0%.

(2) f<sub>T</sub> = |h<sub>fe</sub>| • f<sub>test</sub>.

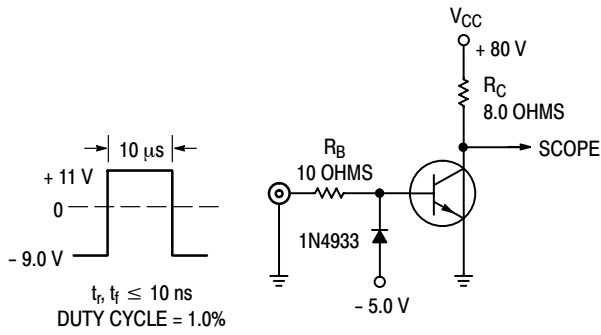

NOTE: For information on Figures 3 and 6,  $R_B$  and  $R_C$  were varied to obtain desired test conditions.

Figure 2. Switching Time Test Circuit

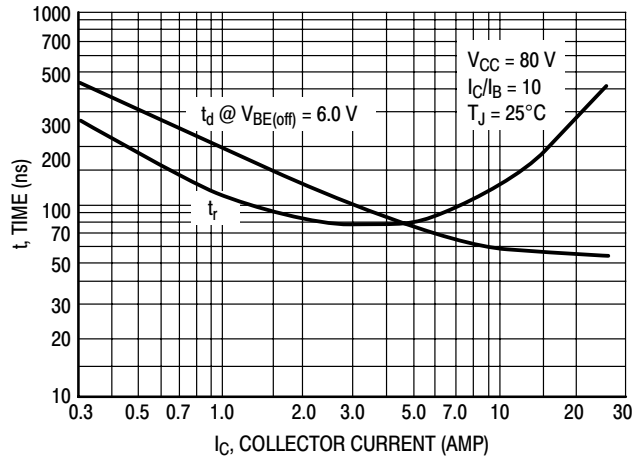

Figure 3. Turn-On Time

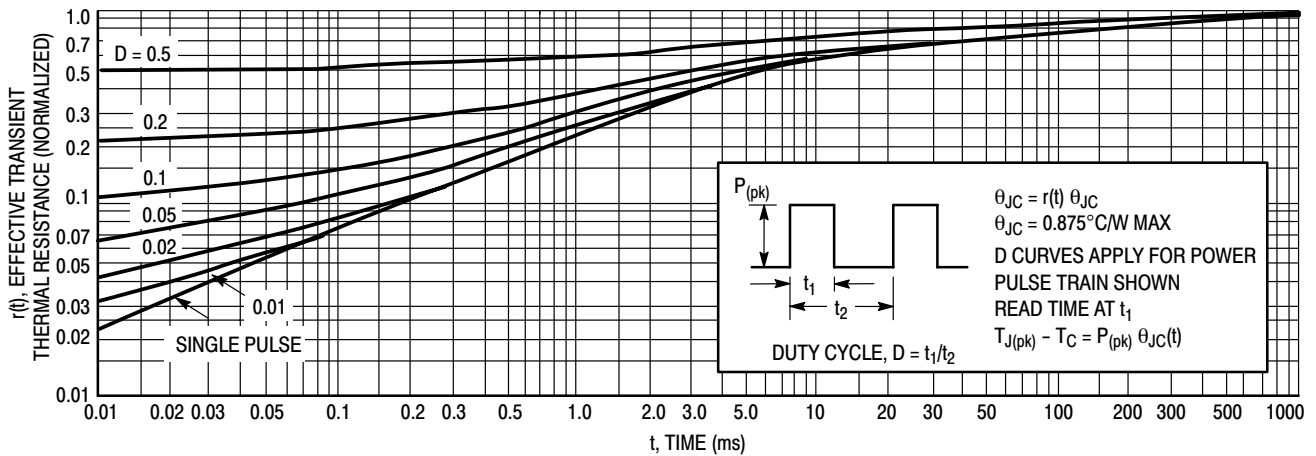

Figure 4. Thermal Response

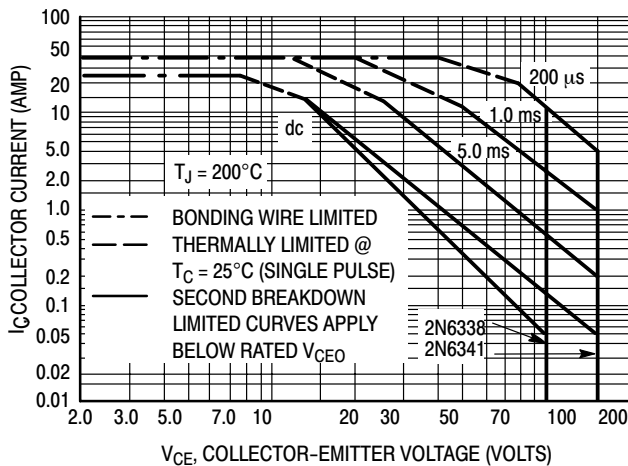

Figure 5. Active Region Safe Operating Area

There are two limitations on the power handling ability of a transistor: average junction temperature and second breakdown. Safe operating area curves indicate  $I_C$ - $V_{CE}$  limits of the transistor that must be observed for reliable operation; i.e., the transistor must not be subjected to greater dissipation than the curves indicate.

The data of Figure 5 is based on  $T_{J(pk)} = 200^\circ\text{C}$ ;  $T_C$  is variable depending on conditions. Second breakdown pulse limits are valid for duty cycles to 10% provided  $T_{J(pk)} \leq 200^\circ\text{C}$ .  $T_{J(pk)}$  may be calculated from the data in Figure 4. At high case temperatures, thermal limitations will reduce the power that can be handled to values less than the limitations imposed by second breakdown.

# 2N6338 2N6341

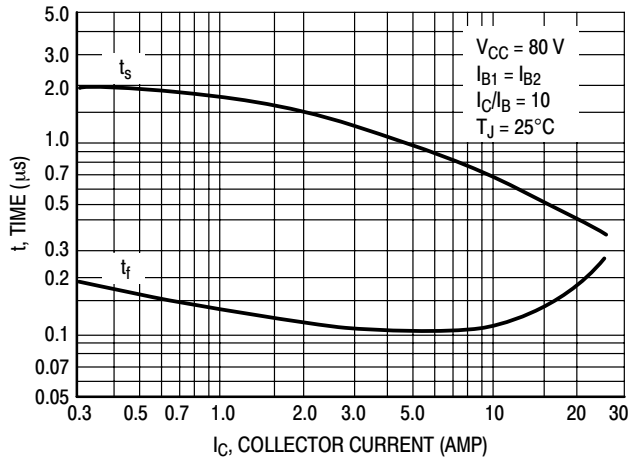

Figure 6. Turn-Off Time

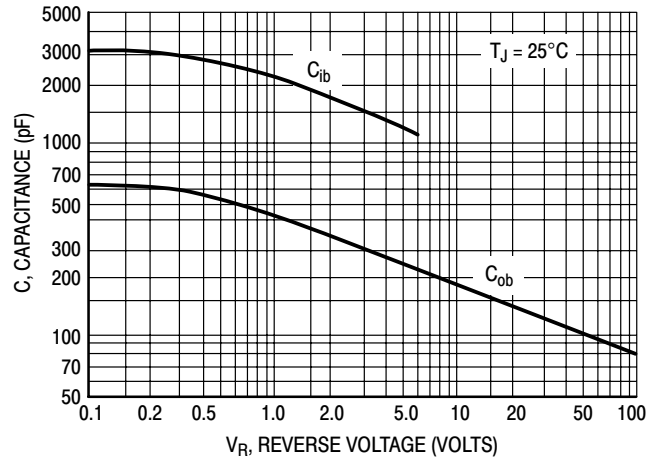
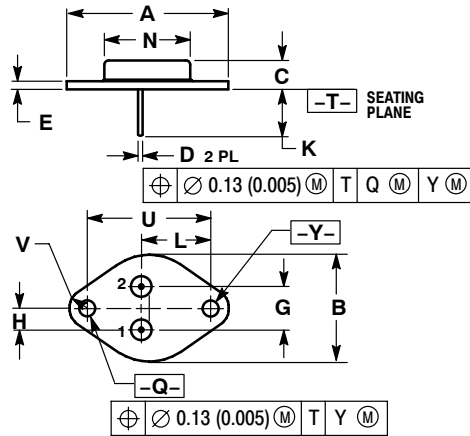

Figure 7. Capacitance

# 2N6338 2N6341

## PACKAGE DIMENSIONS

### CASE 1-07 TO-204AA (TO-3) ISSUE Z



#### NOTES:

1. DIMENSIONING AND TOLERANCING PER ANSI Y14.5M, 1982.
2. CONTROLLING DIMENSION: INCH.
3. ALL RULES AND NOTES ASSOCIATED WITH REFERENCED TO-204AA OUTLINE SHALL APPLY.

DIM	INCHES		MILLIMETERS	
	MIN	MAX	MIN	MAX
A	1.550 REF		39.37 REF	
B	---	1.050	---	26.67
C	0.250	0.335	6.35	8.51
D	0.038	0.043	0.97	1.09
E	0.055	0.070	1.40	1.77
G	0.430 BSC		10.92 BSC	
H	0.215 BSC		5.46 BSC	
K	0.440	0.480	11.18	12.19
L	0.665 BSC		16.89 BSC	
N	---	0.830	---	21.08
Q	0.151	0.165	3.84	4.19
U	1.187 BSC		30.15 BSC	
V	0.131	0.188	3.33	4.77

#### STYLE 1:

1. BASE
  2. EMITTER
- CASE: COLLECTOR

ON Semiconductor and are registered trademarks of Semiconductor Components Industries, LLC (SCILLC). SCILLC reserves the right to make changes without further notice to any products herein. SCILLC makes no warranty, representation or guarantee regarding the suitability of its products for any particular purpose, nor does SCILLC assume any liability arising out of the application or use of any product or circuit, and specifically disclaims any and all liability, including without limitation special, consequential or incidental damages. "Typical" parameters which may be provided in SCILLC data sheets and/or specifications can and do vary in different applications and actual performance may vary over time. All operating parameters, including "Typicals" must be validated for each customer application by customer's technical experts. SCILLC does not convey any license under its patent rights nor the rights of others. SCILLC products are not designed, intended, or authorized for use as components in systems intended for surgical implant into the body, or other applications intended to support or sustain life, or for any other application in which the failure of the SCILLC product could create a situation where personal injury or death may occur. Should Buyer purchase or use SCILLC products for any such unintended or unauthorized application, Buyer shall indemnify and hold SCILLC and its officers, employees, subsidiaries, affiliates, and distributors harmless against all claims, costs, damages, and expenses, and reasonable attorney fees arising out of, directly or indirectly, any claim of personal injury or death associated with such unintended or unauthorized use, even if such claim alleges that SCILLC was negligent regarding the design or manufacture of the part. SCILLC is an Equal Opportunity/Affirmative Action Employer. This literature is subject to all applicable copyright laws and is not for resale in any manner.

#### PUBLICATION ORDERING INFORMATION

##### LITERATURE FULFILLMENT:

Literature Distribution Center for ON Semiconductor  
P.O. Box 61312, Phoenix, Arizona 85082-1312 USA  
Phone: 480-829-7710 or 800-344-3860 Toll Free USA/Canada  
Fax: 480-829-7709 or 800-344-3867 Toll Free USA/Canada  
Email: orderlit@onsemi.com

N. American Technical Support: 800-282-9855 Toll Free  
USA/Canada

Japan: ON Semiconductor, Japan Customer Focus Center  
2-9-1 Kamimeguro, Meguro-ku, Tokyo, Japan 153-0051  
Phone: 81-3-5773-3850

ON Semiconductor Website: <http://onsemi.com>

Order Literature: <http://www.onsemi.com/litorder>

For additional information, please contact your local Sales Representative.